

# AQF-2100H

Automatic Quick Furnace  
Combustion Ion Chromatography



Analysis for Solution

 MITSUBISHI CHEMICAL ANALYTECH CO., LTD.  
Instruments Division

## Advanced, developed to the second generation. Powerful, fast solution for Sulfur and Halogen (Fluoride, Chloride, Bromide and Iodide) analysis.

### Features

#### SKILL FREE OPERATION NEW NO SOOT COMBUSTION PROGRAM FOR COMPLEX, UNKNOWN SAMPLES

Optimum combustion for various matrix is always critical. Program have to be taken care to avoid soot and cleaning frequency.

Newly developed Secure Combustion Program (SCP) function can transfer furnace heat to the sample without overheating. Thanks to this feature, complete combustion can be carried out, even complicated samples, without test run. SCP enables sample sizes to be increased to as much as 150 mg, which provide assuring sample homogeneity. SCP is a standard feature of AQF-2100H without extra cost. Combustion Monitor option visualize pyrohydrolytic status on the display which can eliminate needless time without the risk of soot generation.

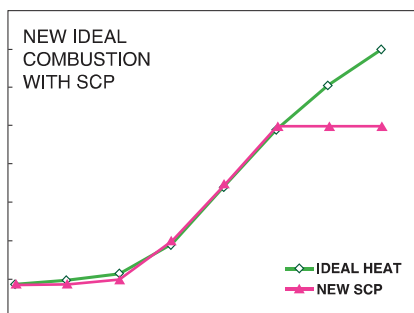
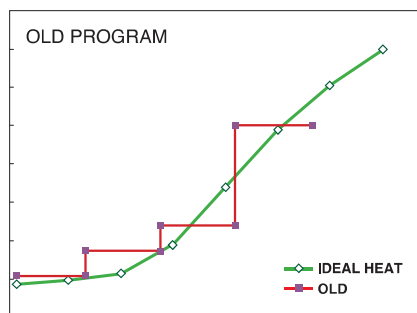

#### PYROHYDROLYTIC COMBUSTION SYSTEM

Controlled pyrohydrolytic combustion enables highly accurate analysis of Fluoride, high concentration Chloride, and Bromide.

#### HIGH SENSITIVE ANALYSIS

Thanks to the dedicated gas controller unit, extremely low gas blank is realized. By utilizing high purity quartz tube, trace analysis can be applicable.

#### ABSORBENT CORRECTION

Constant volume function enables highly accurate analysis and easier operation. Since there is no longer a need to use internal standards, samples with complex matrices can be measured.

#### ACCESSIBILITY

Customer can easily access the combustion tube for daily maintenance. Cleaning and set up of tubes are more convenient.

#### NEW SOFTWARE, FULL AUTOMATIC OPERATION & SHUT DOWN

Fully automatic operation is available from calibration, boat prebake, sample analysis, until auto shutdown.

### Measuring Principle

After samples are thermally digested in the Argon atmosphere they are combusted with oxygen and H<sub>2</sub>O. Sulfur in the samples changes to SO<sub>x</sub> and Halogens turn to Hydrogen Halide and Halogen gas. These elements will be trapped by the absorbent solution, then injected for IC analysis.

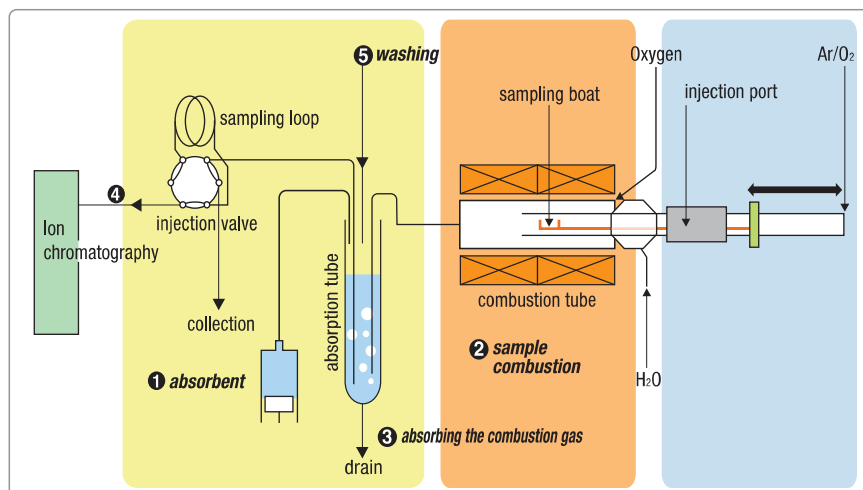
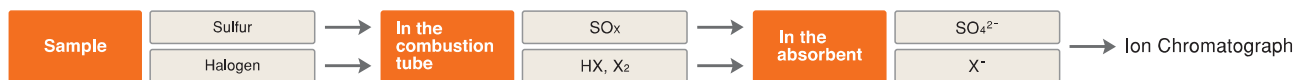

#### Process Flowchart

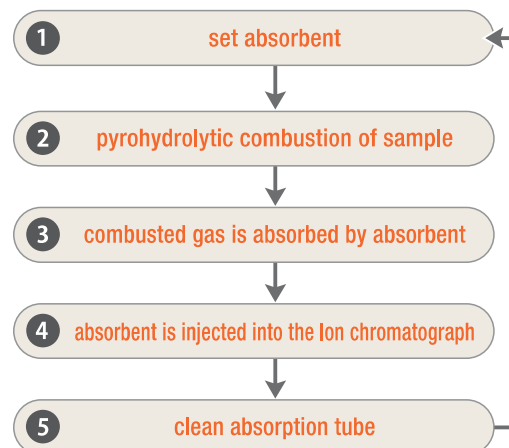

- One combustion program for unknown sample.
- No need for internal standard in absorbent.
- Capable to use by other analyzers, ICP, AA.
- 40 position sampler

## Standard Method

METHOD NUMBER	TITLE	ELEMENTS
ASTM D5987	Standard Test Method for Total Fluorine in Coal and Coke by Pyrohydrolytic Extraction and Ion Selective Electrode or Ion Chromatograph Methods	F
ASTM D7359	Standard Test Method for Total Fluorine, Chlorine and Sulfur in Aromatic Hydrocarbons and Their Mixture by Oxidative Pyrohydrolytic Combustion followed by Ion Chromatography Detection (Combustion Ion Chromatography-CIC)	F, Cl, S
JIS K7392	Total bromine in waste plastics	Br
JIS R9301 (ISO 2828)	Alumina powder: Determination of Fluorine content	F
JIS R1616	Methods for chemical analysis of fine silicon carbide powders for fine ceramics	F, Cl
JIS R1603	Methods for chemical analysis of fine nitride powders for fine ceramics	F, Cl
JIS Z7302	Densified refuse derived fuel – test method for total chlorine/sulfur contents	Cl, S
JEITA ET-7304A	Definition of Halogen-free Soldering Materials	F, Cl, Br, I
KS M0180	Standard test method for halogen (F,Cl,Br) and Sulfur content by oxidative pyrohydrolytic combustion followed by ion chromatography detection for electronic equipment	F, Cl, Br,S

## MAINTENANCE

Open/close furnace: Easier access to the pyrolysis tube in horizontal furnace.

Gas absorption unit: Easy setup by stand alone operation.



## SAFETY FEATURE OF MONITORING

Gas flow: To protect from incomplete combustion, preventing irregular combustion.

Furnace: Emergency shutdown of the system in case of over heating.

Furnace door: Error message will inform open furnace door open.

## GAS ABSORPTION UNIT

Intuitive icon for easy setup and maintenance. Operable by single unit. [Collection] function enables the use of other analyzers, ICP, AA, etc.

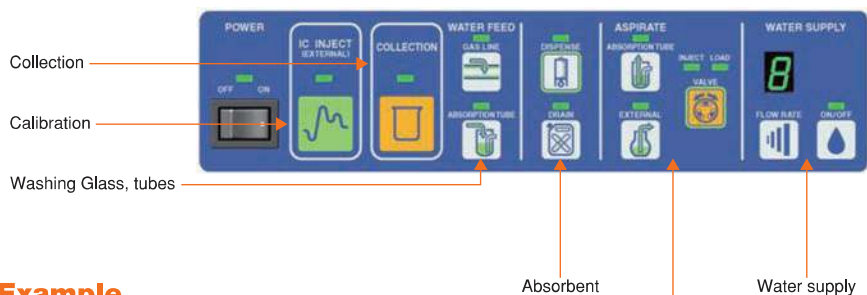

## AQF-2100H System Configuration Example.



## APPLICATION

- Electronics - Printed Circuit Board, IC's, solder, plastics, adhesives
- Organic synthesis - dye, pigment, organic metal, raw material of medicine, intermediates
- Automobile - rubber, plastics



### Polyethylene Standard

#### ■ EC-680K

sample	Cl (ppm)	Br (ppm)	S (ppm)
1	104	96.9	73.8
2	105	95.5	72.8
3	106	97.4	75.5
Avg	105	96.6	74.0
RSD (%)	0.95	1.0	1.8
Certified	102+/-3	96+/-4	76+/-4

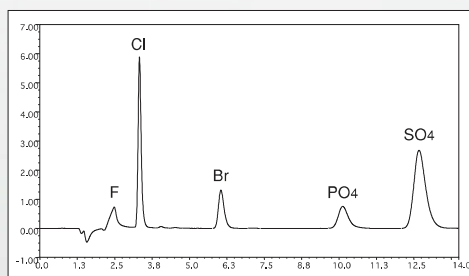

### ABS, Polyethylene. Br Measurement

sample	DBDE Content (%)	Br result (%)	converted value DBDE (%)
DBDE/ABS A	0.1	0.089	0.11
DBDE/ABS B	1.0	0.87	1.04
DBDE/ABS C	10	8.24	9.9
DBDE/Polyethylene A	0.1	0.079	0.096
DBDE/Polyethylene B	6.0	4.93	5.91

DBDE : Decabromodiphenyl Ether

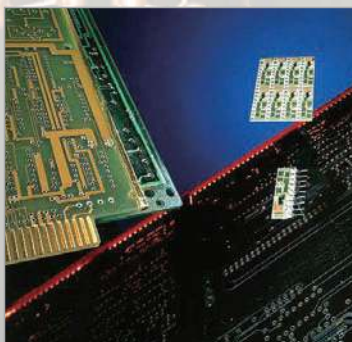

### Halogen Free Solder

sample	F (ppm)	Cl (ppm)	Br (ppm)	S (ppm)
Solder paste	< 5	5.03	36.3	8.11
Flux	< 5	13.6	< 5	57.9
Paste	< 5	1.62	< 5	—



- Mining, ceramics - coal, ceramics, glass
- Petroleum - polymer, rubber, fuel oil, lubricant oil, LPG
- Environment, Wastes - ash, waste water, RPF
- others - lithium cell material, fuel cell

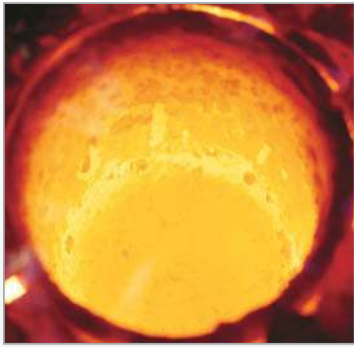

### Fluorine, Chlorine, Sulfur in Coal

sample	F (ppm)	Cl (ppm)	S (%)
Result	84	22	0.81
Certified	72	20	0.80

standard : CANSPEX2003-1



### Sulfur in Fuel TS-100: UVFL

sample	Result (ppm)	Average (ppm)	TS-100 (ppm)
Kerosene	53.8/54.8	54.3	54.2
Regular gasoline	47.6/45.3	46.5	46.2
High Octane	7.05/7.55	7.3	7.4

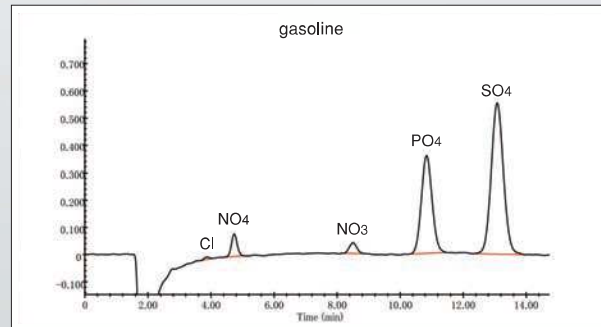

### Fluorine in Lubricant Oil

sample	Result (ppm)	Avg (ppm)
A	2.5/2.7	2.6
B	10.5/10.3	10.4

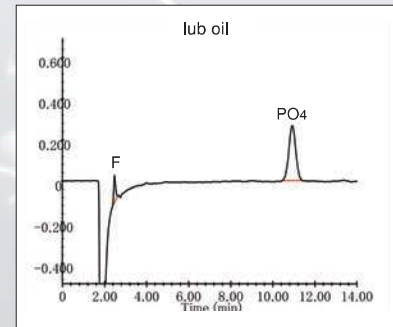

### RPF (Refuse Paper and Plastic Fuel)

sample	F (%)	Cl (%)	S (%)
1	0.007	0.133	0.048
2	0.008	0.148	0.051
3	0.007	0.157	0.050
4	0.007	0.135	0.049
5	0.007	0.165	0.050
average	0.008	0.148	0.050
RSD(%)	6.2%	9.4%	2.3%

\* With combustion improver

## APPLICATION



### Iodine in Kelp

sample	I (ppm)
1	2878
2	2788
Average	2833

### Fluorine in Waste Water

sample	F con. (ppm)	Recovery(%)
NaBF <sub>4</sub> Solution	100	99.2
NaF solution	100	99.1

sample	Results (ppm)	Average
A	10.1/10.3	10
B	5.8/6.3	6.0



### High Concentration Analysis, Composition Analysis, Organic Sample

Standard Sample	element	Theoretical, %	Analysis, % (n)	RSD, %
S-benzylthiuronium chloride	Cl	17.49	17.56 (7)	0.64
	S	15.82	15.59 (7)	0.55
PTFE	F	76	75.6 (3)	1.10
2-Iodobenzoic acid	I	51.17	51.17 (7)	0.51
Thiourea	S	42.12	42.11 (7)	0.45
sym-Diphenylthiourea	S	14.04	13.97 (7)	0.38
Sulfathiazole	S	25.12	25.01 (7)	0.63
(4-chloro-3- trifluoromethyl) phenyl thiourea	F	22.38	22.52 (7)	0.96
	Cl	13.92	13.81 (7)	1.03
1,2,3,4,5,6, -Hexabromocyclohexane	S	12.59	12.48 (7)	0.98
	Br	85.99	86.18 (7)	0.47
2,4-Dinitrochlorobenzene	Cl	17.5	17.56 (7)	0.85
4-Chlorobenzoic acid	Cl	22.64	22.66 (7)	0.28

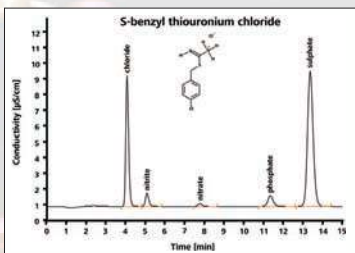

### Inorganic Fluorine Sample

#### Corrosive Sample Analysis

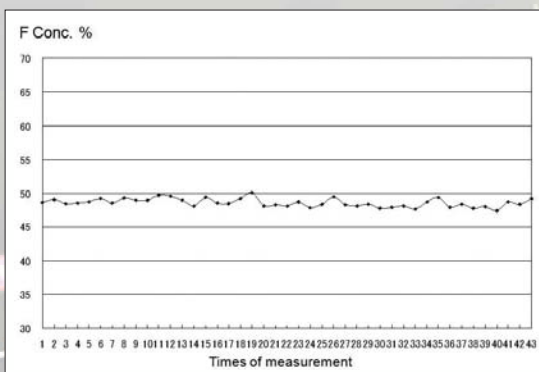

sample:5mg  
ceramic combustion tube with improver

#### Fluorite Standard (NIST)

composition **CaF<sub>2</sub> (75%)** **SiO<sub>2</sub> (20%)**  
contents **F (36.7%)** **S (0.39%)**

sample	Fluorine	Sulfur
Result	35.5 %	0.39 %
certified	36.7 %	0.35 %

## OPTION

### ASC-240S



MODEL	ASC-240S Solid Sample Changer	
Sample	Solid, liquid (manual)	
Amount of sample	Solid 150 mg	Liquid 100 µl
Boat, number of sample	ceramic, 40 pos.	
Sample injection	Auto boat control	
Boat cooling	Peltier	
Power	100 – 240VAC, 50/60Hz, 80VA	
Dimension	480(W) x 460(D) x 520(H) mm	
Mass	31 kg	

### ES-210



MODEL	ES-210 External Solution Selector
Sample	Liquid
Number of sample	max 4
Sample injection	PC control

### ABC-210



MODEL	ABC-210 Auto Boat Controller
Sample	Solid, Liquid
Amount of sample	Solid 150 mg    Liquid 100 µl
Boat	quartz, disposable ceramic
Boat cooling	Peltier
Power	100 – 240VAC, 50/60Hz, 40VA
Dimension	445(W) x 250(D) x 180(H) mm
Mass	9 kg

### GI-220



MODEL	GI-220 Gas Injector
Sample	Non-pressurized gas, Volatile liquid
Injection	10 µl for liquid    25ml by syringe pump for gas
Carrier	Argon
Heat	80°C for liquid
Port	RS-232C COM port
Power	100 -240VAC, 50/60Hz, 70VA
Dimension	180(W) x 360(D) x 500(H) mm
Mass	13 kg

### GI-240



MODEL	GI-240 Gas/LPG injector	
Sample	Gaseous	LPG
Injection	10 ml loop	30 µl loop
Calibration	Standard gas, Liquefied standard gas.	
Carrier	Argon	Argon
Max. pressure	0.1 MPa	5 MPa
Dimension	240(W) x 300(D) x 500(H) mm	
Weight	8 kg	

\*Model GI-250 available

### ASC-250L



MODEL	ASC-250L Liquid Sample Changer
Sample	Liquid (non-aqueous, aqueous)
Injection	max 200 µl (depend on sample)
Inj. speed	0.4 - 50 µl/sec (depend on sample)
Number	50 pos in each 2, 4, 6 ml vial tray.
Power	100 -240VAC, 50/60Hz, 180VA
Dimension	460(W) x 320(D) x 470(H) mm
Mass	16 kg

# AQF-2100H

## Ion Chromatograph (supplied separately)



**DIONEX**  
ICS1600, 2100

Other manufactures have been tested, SHIMADZU, TOSOH, DKK-TOA, etc.

## Efficiently controlled combustion scheduling.

Established program controls total analysis and able to start combustion of the next sample to minimize analysis time.

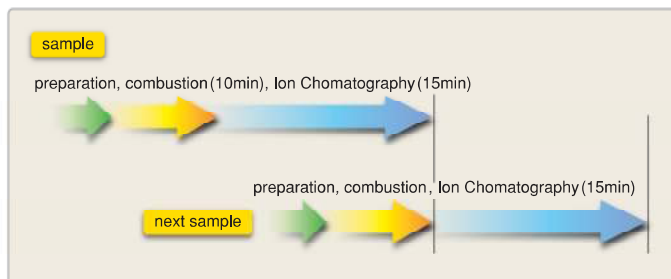

## STANDARD SPECIFICATION

### Model AQF-2100H

Automatic Quick Furnace, sample combustion preparation for Ion Chromatograph.  
(consist of electric furnace, gas absorption and sample introduction)

Sample introduction	Automated boat control
Sample	Solid, Liquid
Amount	1 – 150 mg (solid), 5 – 100 µl (liquid)
Sample pyrolysis	High purity quartz tube (ceramic option)
Combustion	Two split electric furnace, max. 1100°C. Temperature individually controlled
Gas	Argon (≥99.98%, 0.2-0.4 MPa), Oxygen (≥99.7%, 0.2 – 0.4 MPa)
Absorbent tube	10 ml (20ml option)
Injection to IC	Loop 100 µl (5, 20, 50, 200 µl option)
Absorbent dispensing	5ml syringe pump
Tube material	Fluoro-resin, PEEK
Signal output	Contact signal to start Ion Chromatograph
Power	HF-210 100-240VAC, 50/60Hz. 1000VA
	GA-210 100-240VAC, 50/60Hz. 50VA
Dimension, Mass	HF-210 320(W) x 430(D) x 500(H) mm, 25kg
	GA-210 250(W) x 430(D) x 500(H) mm, 22kg

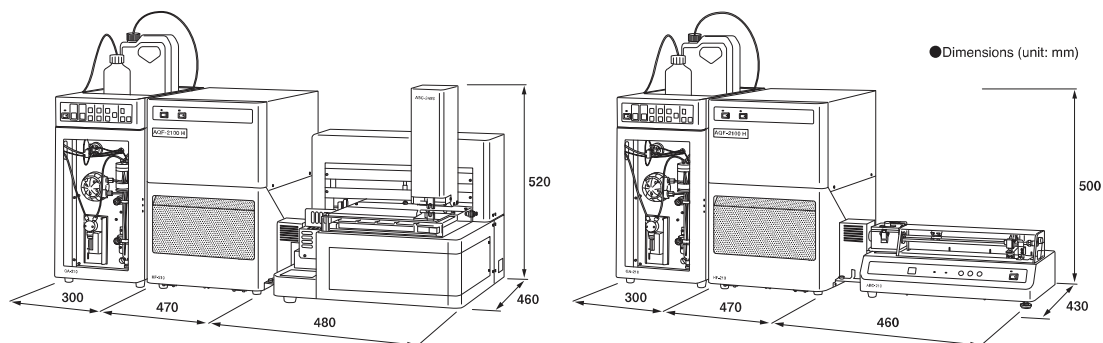

\*Company and product names contained herein are the trademarks or registered trademarks of the company concerned.

**MITSUBISHI CHEMICAL ANALYTECH CO., LTD.**

Instruments Division

370 Enzo, Chigasaki, Kanagawa 253-0084, Japan.

Tel: +81-467-86-3864 Fax: +81-467-86-3862

URL: <http://www.mccat.co.jp>